

構成内容 / Components				
No.	名称 / Part name	数量 / Pcs	材質 / Material	色・表面処理 / Color・Finish
1	上下カバー Top and Bottom cover	各1 1 each	アルミ板 A1100P t2.0 Aluminium A1100P t2.0	シルバーアルマイト Silver anodized
2	Wパネル W panel	2	アルミ板 A1100P t2.0 Aluminium A1100P t2.0	シルバーアルマイト Silver anodized
3	Dパネル D panel	2	アルミ板 A1100P t2.0 Aluminium A1100P t2.0	シルバーアルマイト Silver anodized
4	支柱 Extruded pillar	4	アルミ押出材 A6063S-T5 Extruded aluminium A6063S-T5	シルバーアルマイト Silver anodized
5	取付用ローレットビス (M4 x 8) Knurled thumb screw (M4 - 8)	8	真ちゆう Brass	ニッケルメッキ Nickel plated
6	ゴム足 / Rubber feet	0 or 5	ポリウレタン / Polyurethane	透明 / Transparent

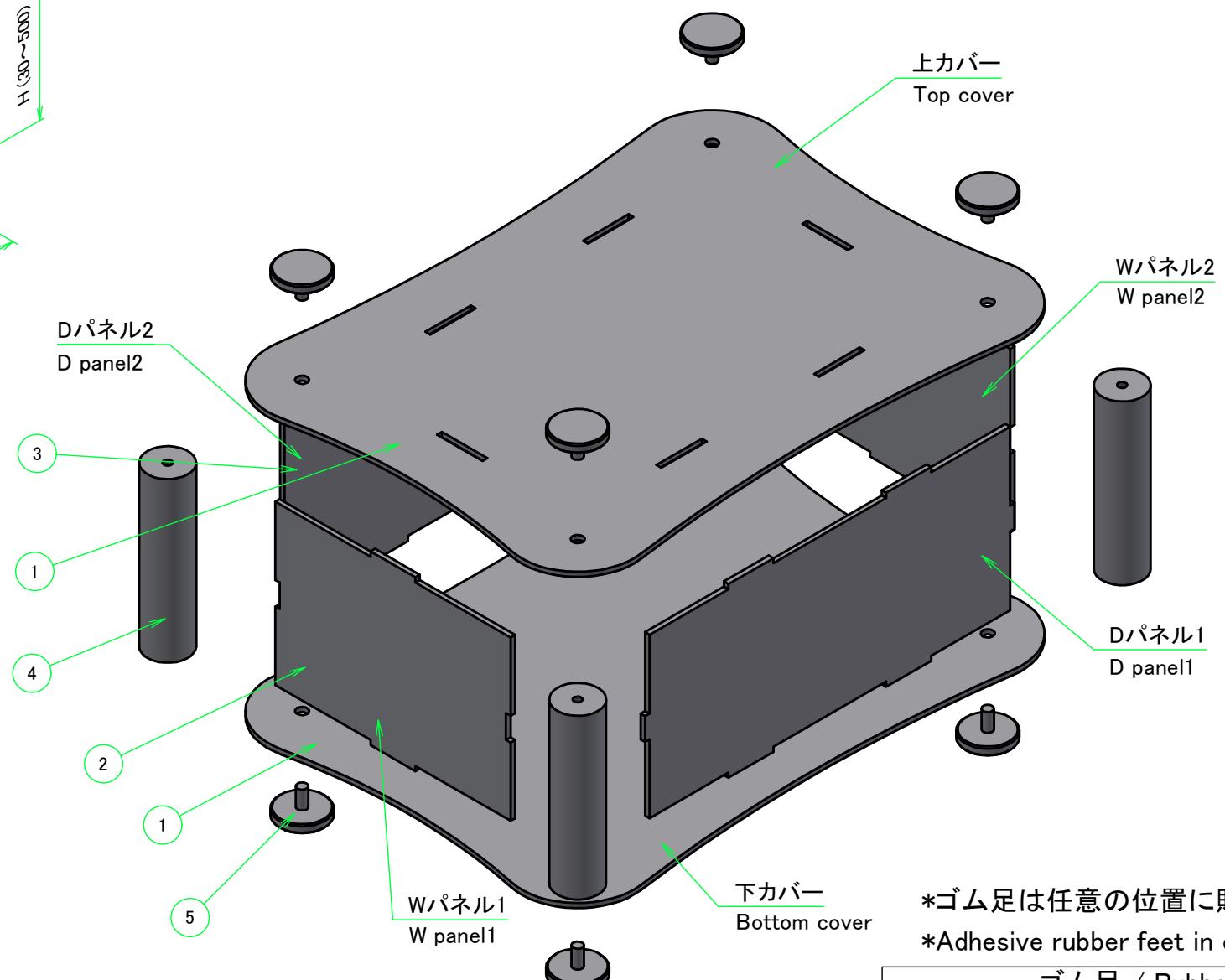

ケース型番 / Product Number

ALRF - - S18
 W H D タイプ ゴム足
 Type Rubber feet

*ゴム足は任意の位置に貼り付けできます。
 *Adhesive rubber feet in cluded

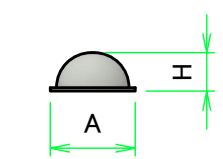

ゴム足 / Rubber feet		
記号 / Code	A	H
N (無し) / None	-	-
S	11.2	5.1
L	15.7	7.9

W・H・D 寸法制限範囲 / Dimension limit range		
W	H	D
401 ~ 450	30 ~ 500	101 ~ 150

株式会社タカチ電機工業 TAKACHI ELECTRONICS ENCLOSURE CO., LTD.			品名/Title 曲線型アルミフリーサイズケース CUSTOM SIZED ARC DESIGN ALUMINIUM ENCLOSURE	尺度/Scale 1 / 5
承認/Approved 中根	検図/Checked 野村	製図/Created 常山	型番/Product number ALRF□-□-□S18□ (W401~450, D101~150) 作成日/Date 2021/08/06	

外視 / External View

Wパネル2 / W panel 2

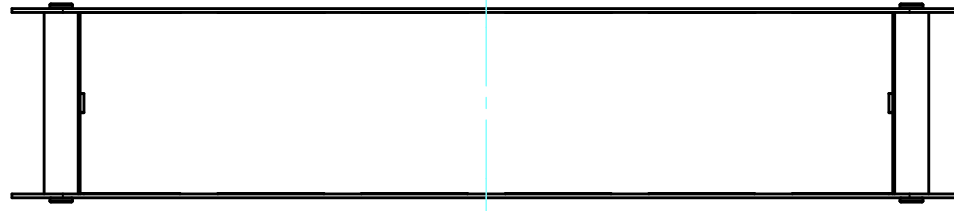

Dパネル2 / D panel 2

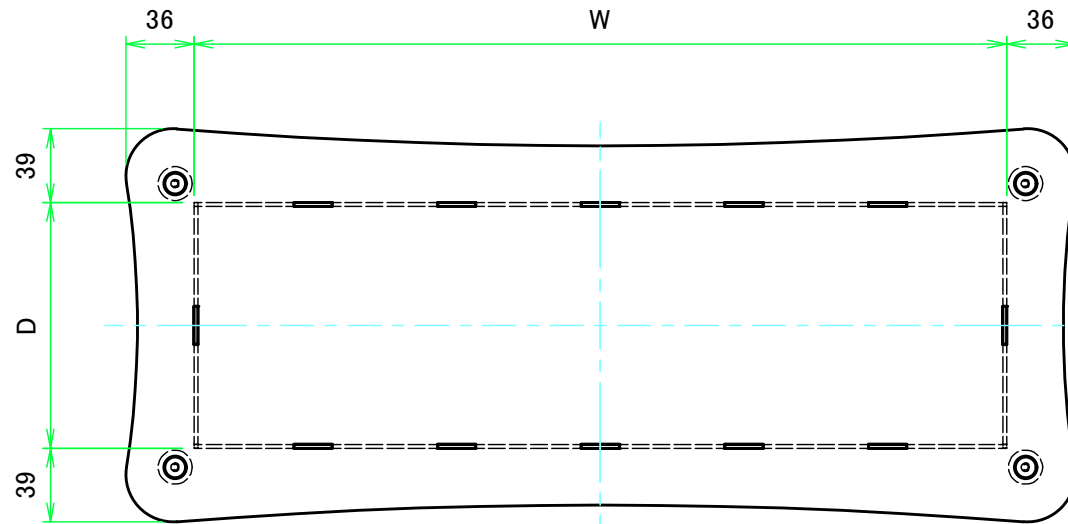
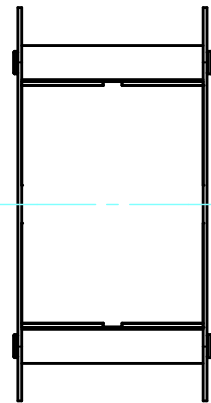

上カバー / Top cover

Dパネル1 / D panel 1

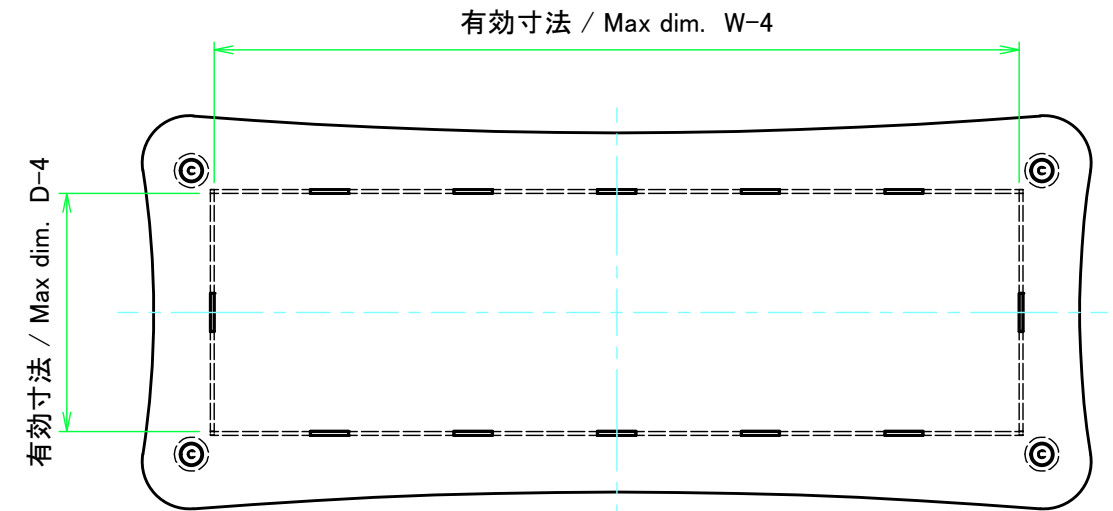
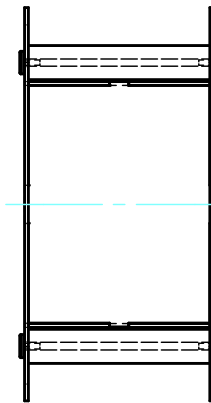

下カバー / Bottom cover

Wパネル1 / W panel 1

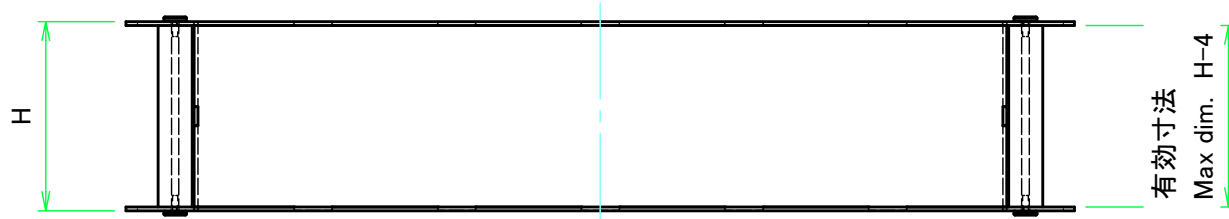

有効寸法
Max dim. H-4

 株式会社タカチ電機工業 TAKACHI ELECTRONICS ENCLOSURE CO., LTD.			品名/Title 曲線型アルミフリーサイズケース CUSTOM SIZED ARC DESIGN ALUMINIUM ENCLOSURE	 尺度/Scale 1:4
承認/Approved 中根	検図/Checked 野村	製図/Created 常山	型番/Product number ALRF□-□-□S18□ (W401~450, D101~150)	
			作成日/Date 2021/08/06	2 / 5

上下カバー / Top and Bottom cover

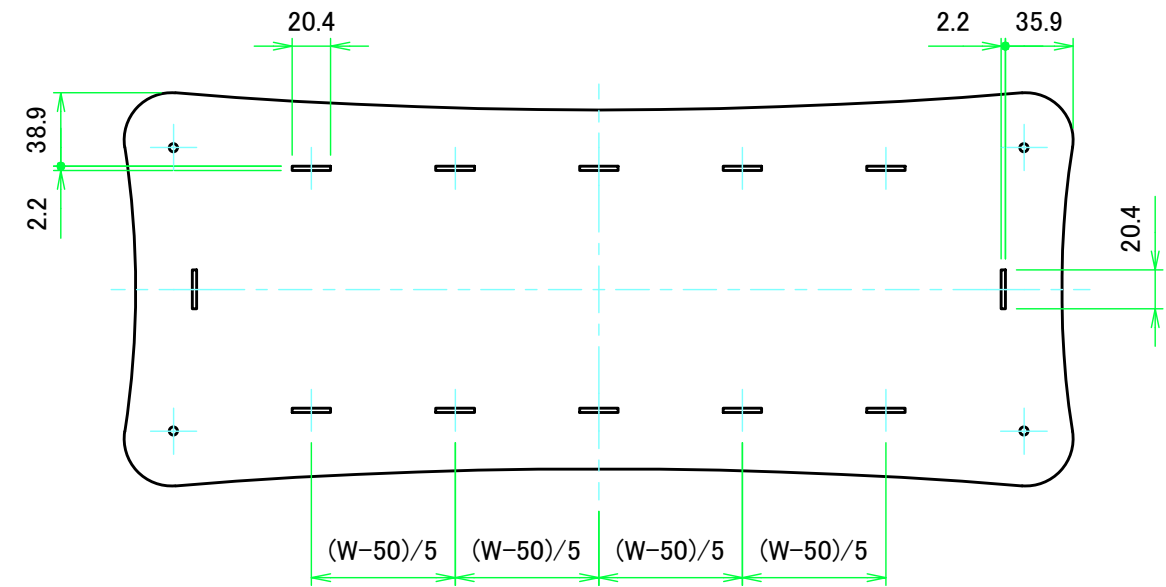
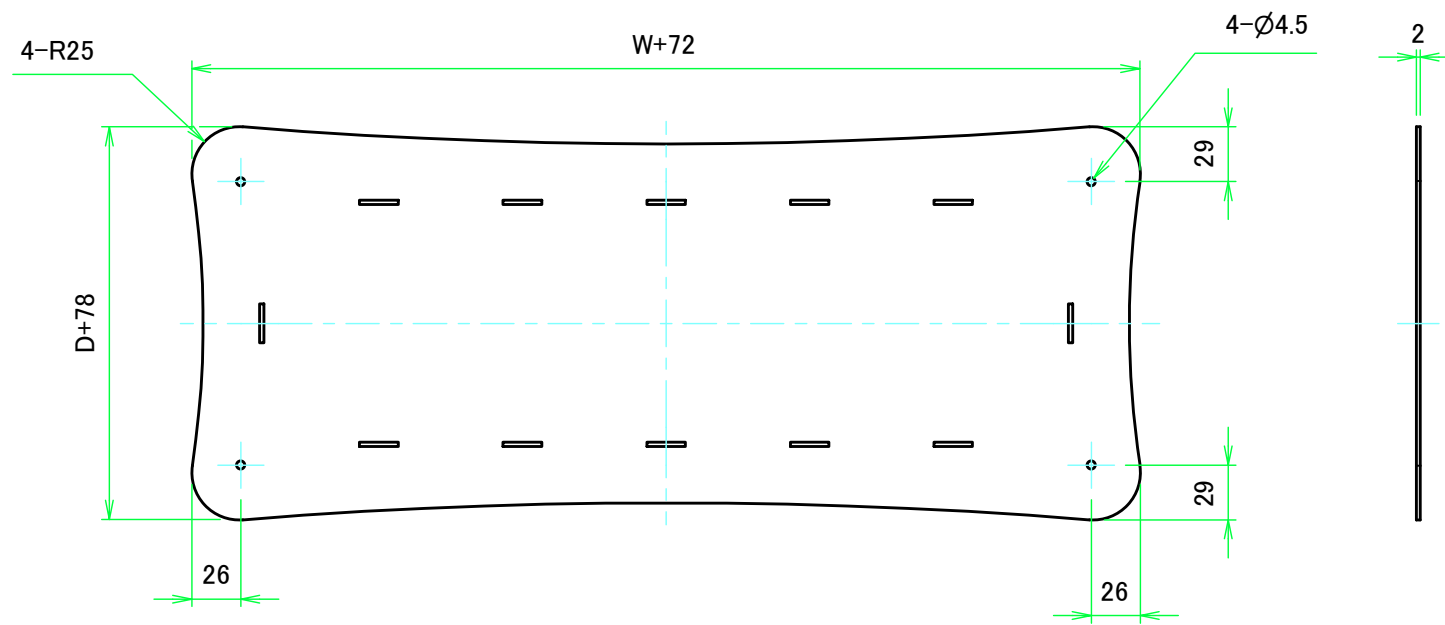

上カバー表面 / Top cover Frontside

上カバー裏面 / Top cover Backside

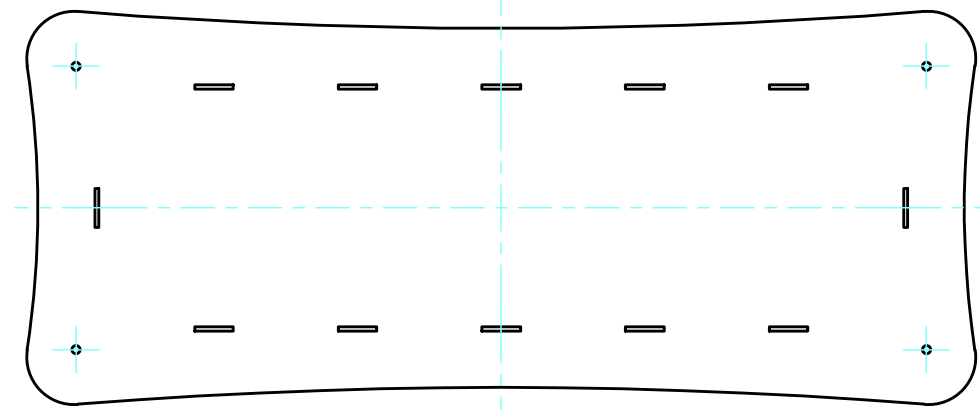
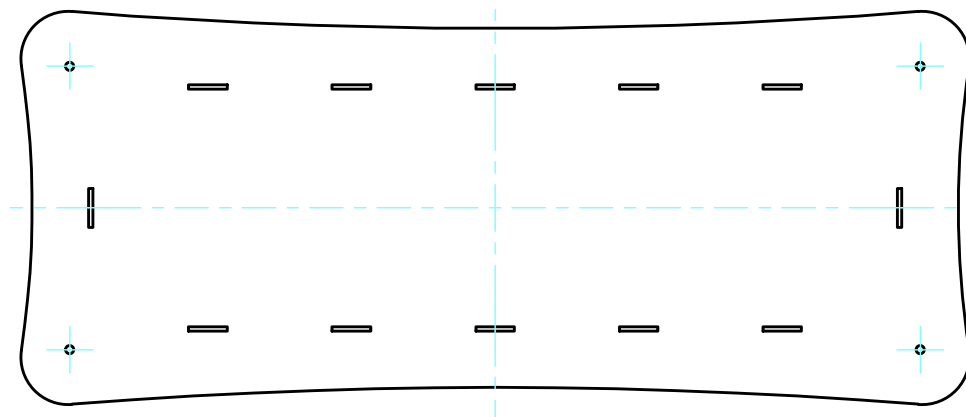

下カバー表面 / Bottom cover Frontside

下カバー裏面 / Bottom cover Backside

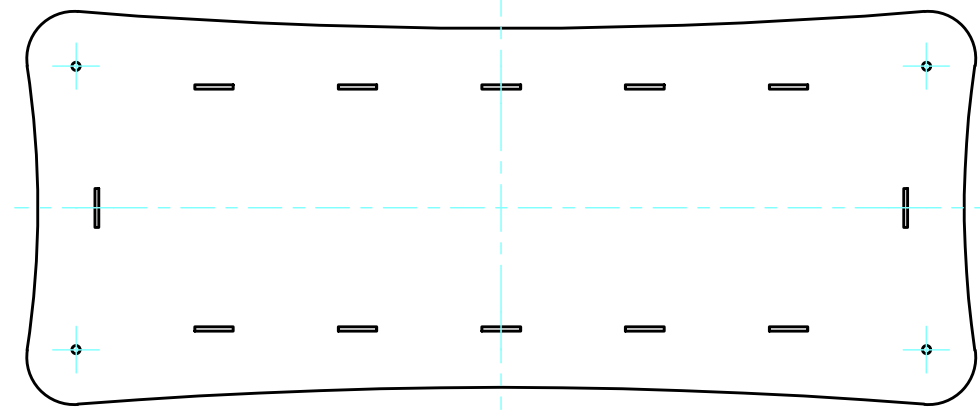
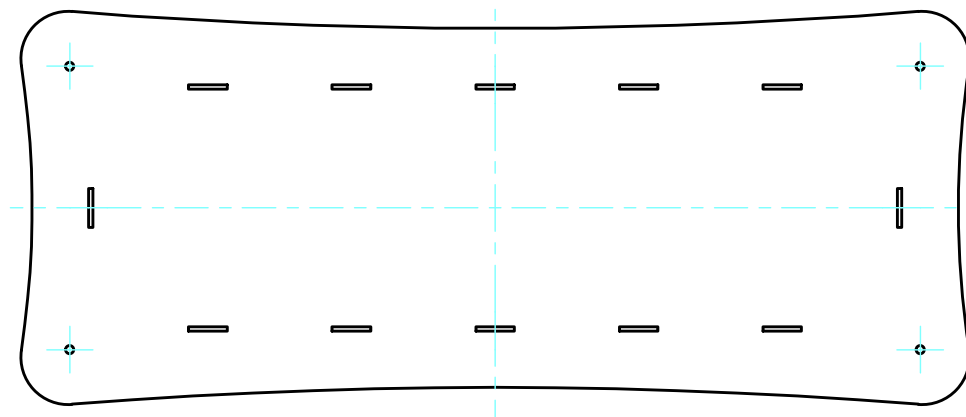

株式会社タカチ電機工業 <small>TAKACHI ELECTRONICS ENCLOSURE CO., LTD.</small>			品名/Title 曲線型アルミフリーサイズケース CUSTOM SIZED ARC DESIGN ALUMINIUM ENCLOSURE	尺度/Scale 1:4
承認/Approved	検図/Checked	製図/Created	型番/Product number ALRF□-□-□S18□ (W401~450, D101~150)	
中根	野村	常山	作成日/Date 2021/08/06	3 / 5

Wパネル / W panel

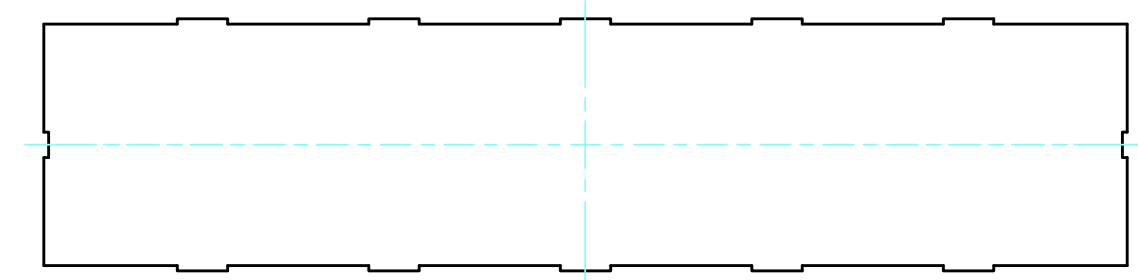
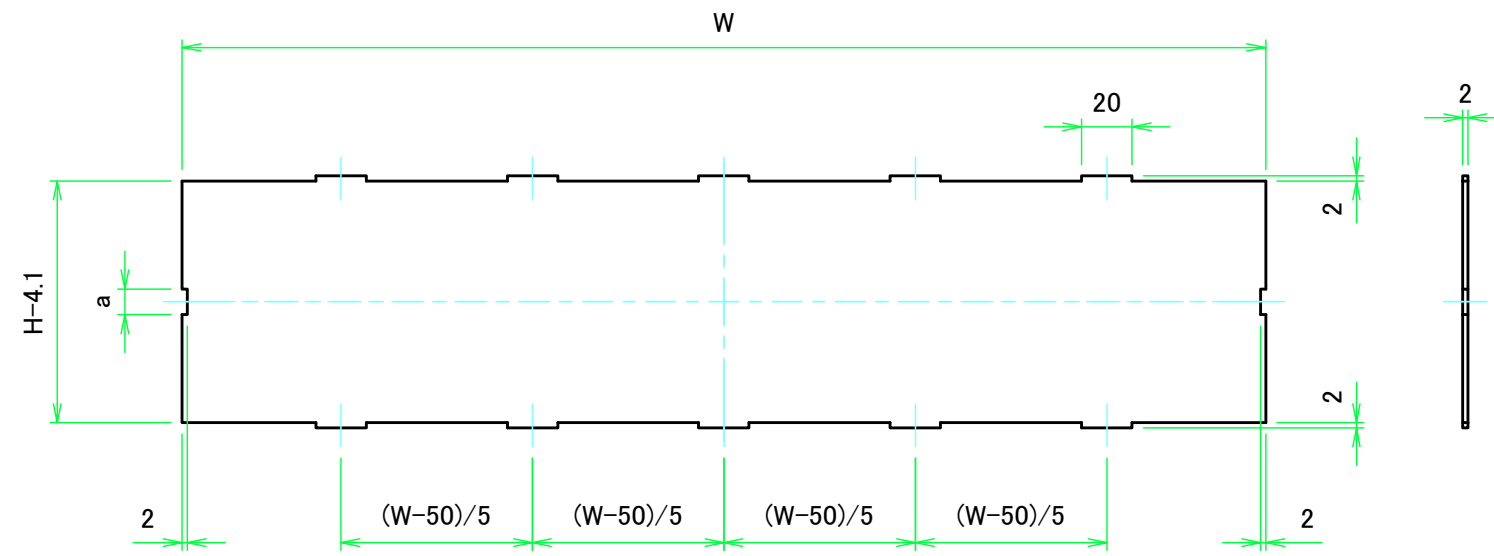

Wパネル1表面 / W panel 1 Frontside

Wパネル1裏面 / W panel 1 Backside

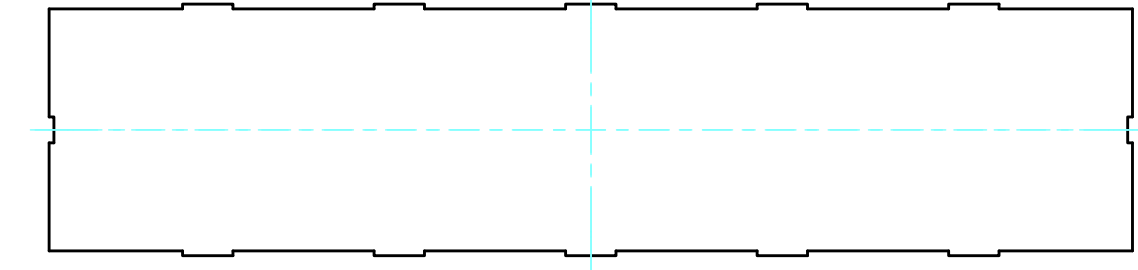
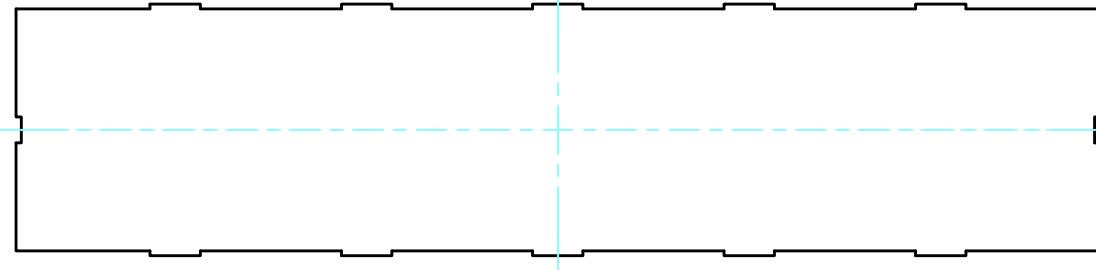

Wパネル2表面 / W panel 2 Frontside

Wパネル2裏面 / W panel 2 Backside

※高さ(H)寸法によりハメ込み部aの寸法、箇所数が異なります。下記表をご確認ください。
 Number of joints vary by specified H dimensions. Refer to the below chart for more information

H寸法 / H dimension	ハメ込み部a / joint a dimension	箇所数(片面) / Joints(one side)
30 ~ 100	10.2	1
101 ~ 200	20.2	1
201 ~ 300	20.2	2
301 ~ 400	20.3	3
401 ~ 500	20.3	4

株式会社タカチ電機工業 TAKACHI ELECTRONICS ENCLOSURE CO., LTD.			品名/Title 曲線型アルミフリーサイズケース CUSTOM SIZED ARC DESIGN ALUMINIUM ENCLOSURE	尺度/Scale 1:3
承認/Approved 中根	検図/Checked 野村	製図/Created 常山	型番/Product number ALRF□-□-□S18□ (W401~450, D101~150)	
			作成日/Date 2021/08/06	4 / 5

Dパネル / D panel

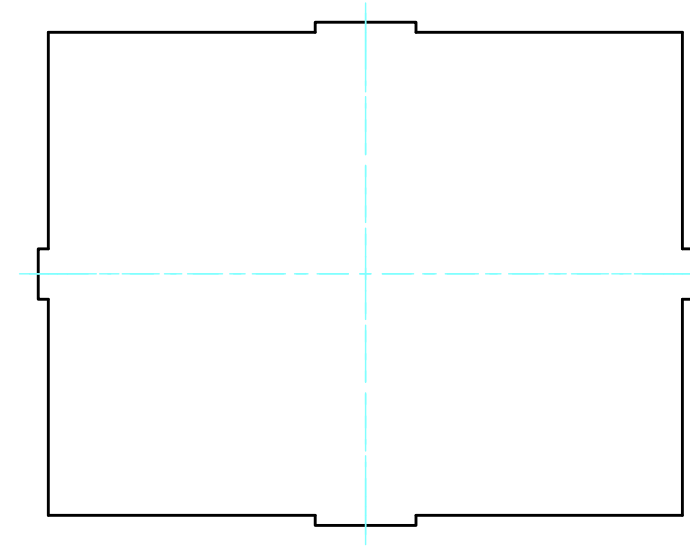
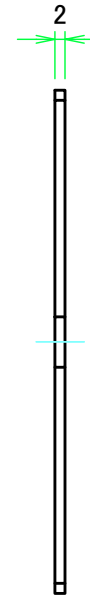
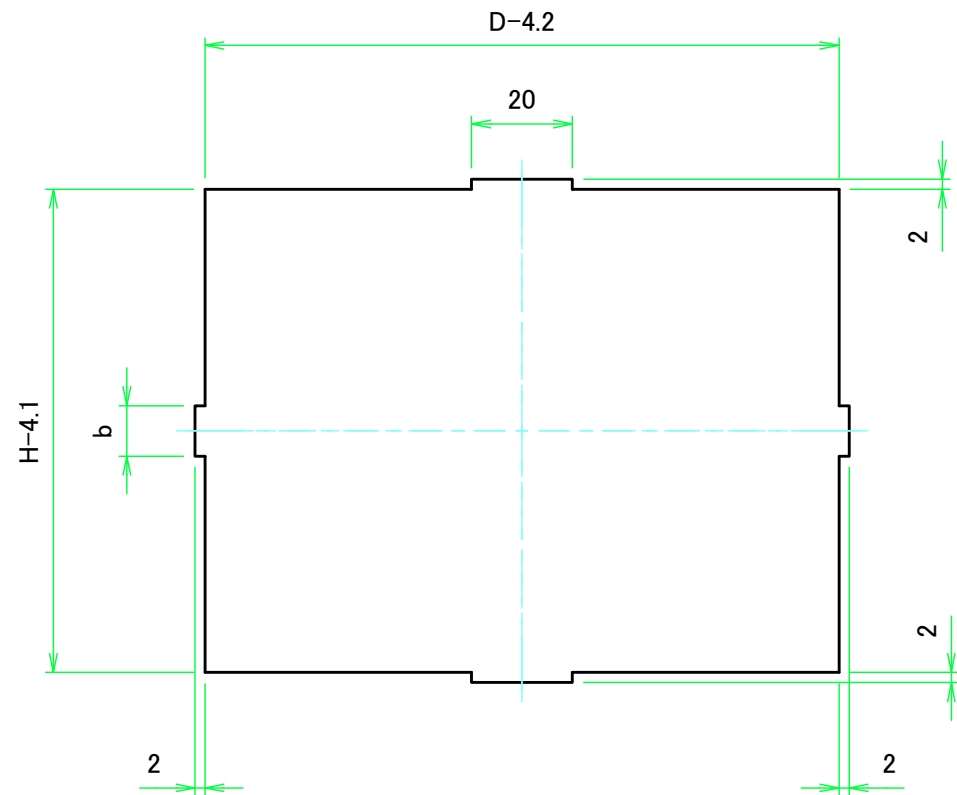

Dパネル1表面 / D panel 1 Frontside

Dパネル1裏面 / D panel 1 Backside

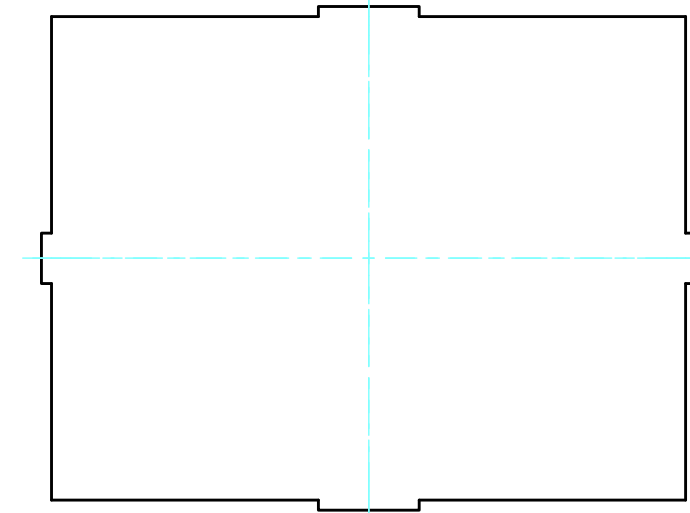
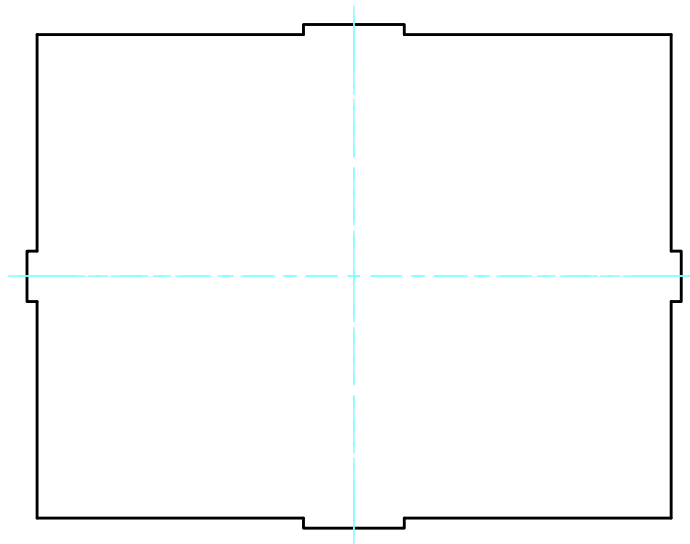

Dパネル2表面 / D panel 2 Frontside

Dパネル2裏面 / D panel 2 Backside

※高さ(H)寸法によりハメ込み部bの寸法、箇所数が異なります。下記表をご確認下さい。

Number of joints vary by specified H dimensions. Refer to the below chart for more information

H寸法 / H dimension	ハメ込み部b / joint b dimension	箇所数(片面) / Joints(one side)
30 ~ 100	10	1
101 ~ 200	20	1
201 ~ 300	20	2
301 ~ 400	20	3
401 ~ 500	20	4

株式会社タカチ電機工業 <small>TAKACHI ELECTRONICS ENCLOSURE CO., LTD.</small>			品名/Title 曲線型アルミフリーサイズケース CUSTOM SIZED ARC DESIGN ALUMINIUM ENCLOSURE	尺度/Scale 1:1.5
承認/Approved 中根	検図/Checked 野村	製図/Created 常山	型番/Product number ALRF□-□-□S18□ (W401~450, D101~150)	
			作成日/Date 2021/08/06	5 / 5